









PZ200 SWIMMING POOL PUMP INSTALLATION AND OPERATING INSTRUCTIONS



	<p>SERIOUS INJURY OR DEATH MAY OCCUR IF THIS PRODUCT IS NOT USED, OPERATED OR INSTALLED ACCORDING TO THESE INSTRUCTIONS AND RELEVANT AUSTRALIAN STANDARDS.</p>
<p>WARNING</p> 	<p>THIS APPLIANCE IS NOT INTENDED FOR USE BY PERSONS (INCLUDING CHILDREN) WITH REDUCED PHYSICAL, SENSORY OR MENTAL CAPABILITIES, OR LACK OF EXPERIENCE AND KNOWLEDGE, UNLESS THEY HAVE BEEN GIVEN SUPERVISION OR INSTRUCTION CONCERNING USE OF THE APPLIANCE BY A PERSON RESPONSIBLE FOR THEIR SAFETY. CHILDREN SHOULD BE SUPERVISED TO ENSURE THEY DO NOT PLAY WITH THE APPLIANCE.</p>
<p>WARNING</p> 	<p>PUMP PRODUCES HIGH PRESSURES – STAND CLEAR OF PUMP AND ALL FILTRATION EQUIPMENT DURING START UP.</p>
<p>WARNING</p> 	<p>PUMP MUST ONLY BE INSTALLED BY A QUALIFIED POOL INDUSTRY PROFESSIONAL. INSTALLERS, OPERATORS AND OWNERS MUST READ THESE INSTRUCTIONS BEFORE USE.</p>
<p>WARNING</p> 	<p>PUMP AUTOMATICALLY RESTARTS AFTER HIGH LIMIT OPERATION, DISCONNECT POWER TO PUMP BEFORE MAINTENANCE OR REPAIR.</p>
<p>WARNING</p> 	<p>INCORRECT SETTING OF THE SPEEDS ON THIS PUMP MAY CAUSE ADVERSE FILTRATION OR OPERATION OF THE SWIMMING POOL OR SPA. ENSURE PUMP IS INSTALLED, SET AND COMMISSIONED BY AN AUTHORISED ASTRAL POOL DEALER.</p>

WARNING

TO AVOID A SAFETY HAZARD, THE SUPPLY CORD IF DAMAGED, MUST ONLY BE REPLACED BY ASTRAL POOL, OR IT'S SERVICE AGENT OR A SUITABLE QUALIFIED PERSON.

.GENERAL

The PZ200 Filtrite by Hurlcon Pump is a unique 2 speed motor combined with an energy efficient pump wet end. When installed and plumbed correctly, the PZ200 will significantly reduce operating costs, lower noise levels and reduce greenhouse emissions.

Model	High	Low
PZ200	489 lpm	234 lpm

(Flow rates based on a maximum speed at 8 m total dynamic head).

Both speeds can be easily changed to suit your application. The PZ200 Series pump must be installed by a pool professional trained by Clark Rubber to ensure it has been selected for the correct application, correctly installed and set up to suit your pool and its operation fully explained to you.

FEATURES

- Continuous duty rated motor
- Precision reinforced moulded high head impeller, giving extra performance
- Single piece moulded body for added strength and longer life
- Rapid priming diffuser quickly corrects loss of water flow
- Quick and easy disassembly for servicing
- Large capacity basket with easily removed ramp on lid
- Ability to adjust speed for optimum water flow and maximum energy savings for your pool and its equipment.
- Double Insulated water circuit for maximum electrical protection

DIMENSIONS

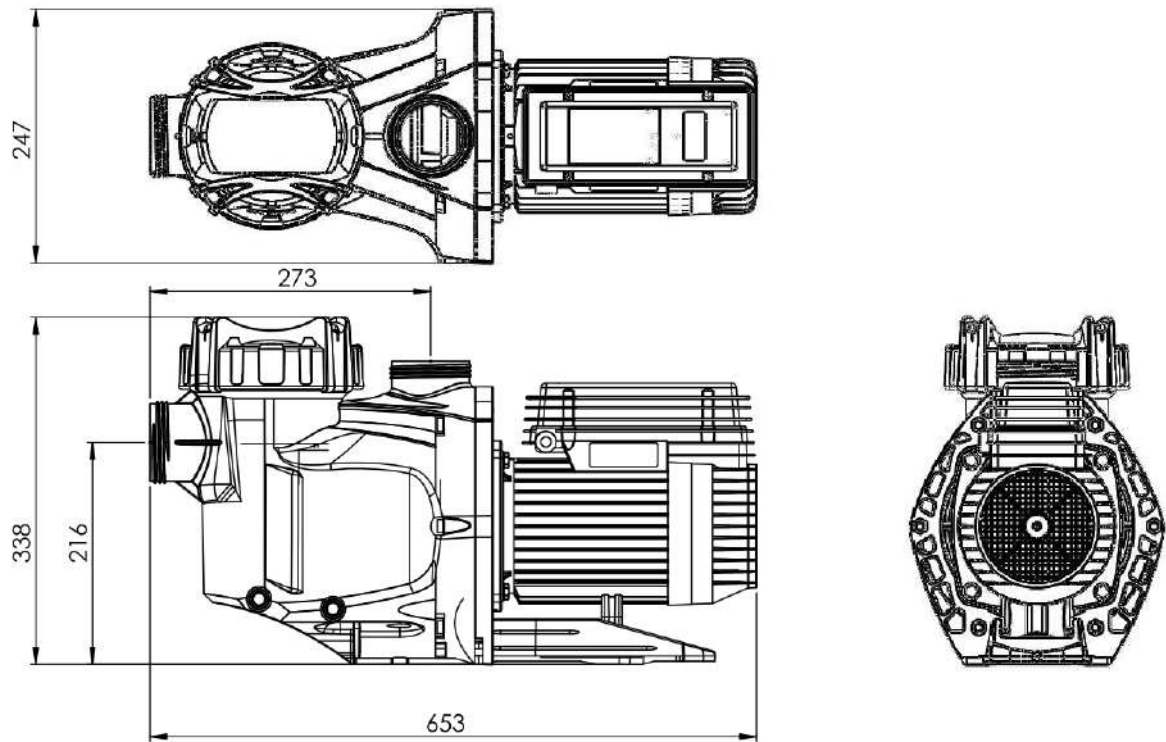

INSTALLATION

This appliance must be installed by a trained pool professional service technician. When installing the appliance, ensure all parts are installed in the correct zone in accordance with the wiring rules. In particular refer to AS/NZS 3000 (Australia) and EN 60364 (EU).

A. Plan position of pump so that it will be:

1. Free of water flooding, such as in a sump, garden hollow, ditch or at bottom of bank with run off.
2. On a stable base so that:
 - a) The pump is not left suspended by its fittings, causing a leak or failure with loss of water.
 - b) Movement through vibration is restricted
 - c) No strain is put on attaching pipe or other expensive equipment
3. Accessible for maintenance and easily removed for service.
4. Breathing space. Pump should not be crowded which will prevent cooling airflow from fan. Overheating due to lack of cooling voids warranty.
5. Within reach of power point without extension/plugs liable to corrosion, shorting, etc.
6. At a minimum height of suction for lift of water from pool surface to pump inlet.

B. For best pump performance keep suction pipe length as short as possible with minimum number of bends and use 50mm high pressure PVC suction and return pipe. All equipment such as filters, heaters, chlorinators must have a minimum of 50mm connections.

C. Secure the barrel unions supplied into the attaching pipe work, using approved priming fluid and solvent cement as normal practice, coating both surfaces. **NOTE:** Always wear protective gloves when handling and using glue and priming fluid. Ensure no excess adhesive runs into the union proper affecting the sealing or removal abilities. Allow 24 hours to dry before starting pump. **DO NOT USE "GREEN" glue on barrel unions.** This can cause damage to the ABS material used to manufacture the unions.

D. Install isolation valves before the pump section and after equipment, if the pump is below the water level of the pool.

- E. For pump installations 500mm above water level, it generally requires a foot valve at the pool or check valve in the suction line. Suction lines must be installed below water level until just in front of pump location and vertical riser used to reach pump inlet. Filtrite by Hurlcon pumps are rated to a maximum head of 25 metres however refer to your pumps data plate for actual achievable pressure
- F. All pumps will operate quieter and perform more efficiently if a straight length of 450mm pipe is plumbed horizontally into the front of the pump.
- G. Water temperature not to exceed 35C degrees
- H. Pumps must be either
 - a. Supplied by an isolated transformer, or
 - b. Supplied through a residual current device (RCD) with a rated residual operating current not exceeding 30mA.

OPERATION

1. Switch on power to pump, motor to start.
2. If some flow of water does not establish within on half minute, switch off and prime pump again. If pump does not prime within 3 attempts, check all suction connections for sealing. If these are satisfactory, a check or foot valve is required to hold water for prime.
3. If the water flow through pump is always tedious to obtain at start-up after cleaning the lint basket, then an examination of the system to establish a reason and correct the cause is recommended. Eg. Check valve, air leaks, faulty seal, cracked lint pot lid, etc.
4. The PZ200 has 2 set speed settings – Low and High. High should be used when backwashing, manually vacuuming the pool or operating spa jets or some water features such as waterfalls. Low speed can be used for gentle spa jet action, when suction cleaner is connected to the skimmer or filtration for the pool. Low is the recommended setting for everyday filtration of your pool when a cleaner is not connected.
5. The PZ200 will automatically start on High for the first 5 minutes to assist in priming and substantially fill the hair and lint pot with water. After 5 minutes the pump will revert to the last speed it was set at before it was turned off.
6. During normal operation, it is recommended that the pump be operated on Low for 12 hours per day. This will achieve the lowest operating costs with the lowest noise level. Should your pool have areas where water is not turning over when pump is on Low, increase the speed setting.

Notes: The appliance is not intended for use by person including young children or infirm persons with reduced physical, sensory or mental capabilities, or lack of experience or knowledge, unless they have been given supervision or instruction concerning use of the appliance by a person responsible for their safety.

Please ensure that young children are supervised to ensure that they do not play with the pump.

To avoid a safety hazard, the supply cord if damaged, must only be replaced by AstralPool, or its service agent or a suitably qualified person.

The PZ200 pump is designed to operate in ambient temperatures of 2°C to 40°C.

Hours of Operation

INST XXX PZ200 Filtrite Pool & Spa Pump V01

On low speed your PZ200 pump makes very little noise and is unlikely to be intrusive to you or your neighbor's. Generally, your pool filter pump should operate for a minimum of 8 hours a day to provide sufficient skimming (thereby reducing the amount of debris that falls to the bottom of the pool) and to allow the chlorinator to provide sufficient chlorine to sanitise your pool.

Greater energy savings occur when operating the pump for longer periods at the low speed instead of operating for shorter periods at the high speed.

SELECTION OF APPROPRIATE SPEEDS

General Rules:

- The total volume of water in your pool should be turned over at least once a day.
- If operating for longer periods of time, you may be able to turn the output of your salt chlorinator to a lower level. Check your chlorine level frequently to ensure you do not over or under chlorinate your swimming pool.
- **Low Speed** is the recommended setting for your daily filtration flow rate – enough to gently turn the water over once per day and circulate the water completely around your pool.
- **High Speed** is generally set up to backwash your sand filter. As a rule of thumb, this speed should be set so that the gauge on your filter is approximately 70kPa to 100 kPa in pressure but this will depend on the size of your filter, and the size and length of the backwash pipe line. Other purpose flow rates may include but are not limited to: operating spa jets, operating water falls or water features, operating a suction pool cleaner.

In warmer weather, or when the pool is used a lot, your pump should operate for 12 hours a day or more. Check your chlorine levels and visually inspect your water to ensure that (a) you have adequate chlorine and (b) the water in your pool looks clear and inviting. If you have any doubts, take a sample of water to your local pool shop for a water analysis.

Examples of Speed Selection during operation and use of your PZ200 Pump:

<i>Function</i>	<i>Speed</i>
Vacuuming Pool or Spa	High Speed
Operating Spa Jets	High Speed
Cleaning up pool with Cloudy Water	Low Speed or High Speed, depending on effect required
General Filtration	Up to 24 hours on High Speed Low Speed (8 hours in winter, 8 to 12 hours in summer)

Some Tips:

The PZ200 will provide around 29,000 litres per hour on high speed, depending on pipework, valves, filter size and other equipment installed on your pool. On low speed the flow rate is approximately 14,000 litres per hour, therefore, operating the pump 4 hours per day will provide a 56,000 litre pool one complete turn over. . **Low speed will use approximately 20% of the power consumption** that high speed will use.

As a guide, low speed should achieve a visible skimming of the surface of the pool through your skimmer box. However, should your pool water develop cloudiness or your pool surface exhibit algae growth you may need to increase the time on high speed to ensure adequate circulation of water and chlorine to all parts of your pool.

It is important to check your chlorine levels, pH and other parameters to ensure your water quality is correct before adjusting the speed of your pump. We recommend these checks are carried out by your professional pool shop or service technician.

OPERATION OF CONTROL PANEL

The PZ200 pump incorporates a user panel that allows you to select between low speed and high speed simply by pressing the desired button. The selected speed will be highlighted by a green LED above the button.

When plugged into power the pump will automatically start and run on High Speed for 5 minutes. It will then revert to the speed it was previously set on.

To turn the pump off switch it off at the power point.

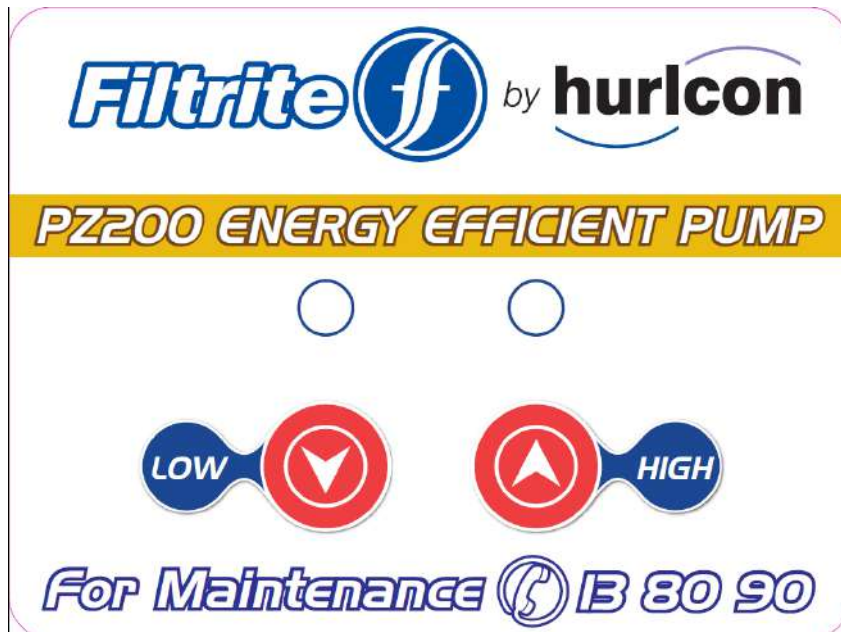

USE WITH SUCTION CLEANERS

When connecting a suction cleaner to the PZ200, it essential that full prime is achieved on the pump prior to connecting the cleaner hose. During operation at low speeds, the pump may only operate with partial prime in the hair and lint pot chamber.

To operate a suction cleaner on your pump;

1. Choose the High speed button.
2. Allow pump to operate for a minimum of 2 minutes to allow a full prime to be achieved.
3. Connect cleaner plate and hose to skimmer/wall suction only after all air has been purged from the top of the hair and lint pot of your PZ200 Pump.
4. When cleaner is no longer required, disconnect and remove hose/cleaner plate from system. Select the lowest filtration speed that keeps your pool clean.
5. If replacing or selecting a new cleaner, Clark Rubber recommend a Filtrite by Maytronics Robotic Cleaner which operates independently from the filter pump and allows the pump to operate at a speed which offers the maximum energy (and cost) savings.

MAINTENANCE

Maintenance Schedule: You new product incorporates moving parts and withstands high velocity water with chemicals in it. Some of these parts will wear in the normal course of use and require regular checks and maintenance. Performing these checks and maintenance will identify parts that have worn and require repair/replacement before further serious damage is sustained. A small amount of regular care and attention to your pool equipment will help ensure long life and trouble free performance.

Timing	Maintenance Check	Service action (if required)
Weekly or sooner	Check and empty hair and lint basket	Empty leaves and debris
Three Monthly	Check Lid O ring and inlet/outlet O rings for leaks	Isolate Pump, turn power off, clean and grease O rings or replace if necessary
Three Monthly	Check surroundings for leaves, debris and flooding	Remove debris and rectify if any flooding
Three Monthly	Check for leaks from underneath pump	Call Service technician, repair or replace mechanical seal and motor bearings if necessary

Important note: Regular maintenance is important to ensure long life and trouble free performance of your pool equipment. If unable to perform the maintenance yourself, contact your local Astral Pool office who will arrange a trained service technician to perform the maintenance for you.

WARRANTY

AstralPool Australia Pty Ltd (ABN 97 007 284 504) ("AstralPool") provides the following warranty in relation to the PZ200 Filtrite by Hurlcon Pool and Spa pump.

Our goods come with guarantees that cannot be excluded under the Australian Consumer Law. You are entitled to a replacement or refund for a major failure and for compensation for any other reasonably foreseeable loss or damage. You are also entitled to have the goods repaired or replaced if the goods fail to be of acceptable quality and the failure does not amount to a major failure.

The benefits of this warranty are in addition to any rights and remedies imposed by Australian State and Federal legislation that cannot be excluded. Nothing in this warranty is to be interpreted as excluding, restricting or modifying any State or Federal legislation applicable to the supply of goods and services which cannot be excluded, restricted or modified.

WARRANTY

AstralPool warrants that, subject to the exclusions and limitations below, the Product will be free from defects in materials and workmanship during the warranty period. The warranty periods are set out below and commence 30 days after the date of purchase (to allow for installation). The warranty period may vary for different parts of the Product.

Parts	Warranty Period
Complete assembly	3 years

If a defect appears in the Product before the end of the warranty period and AstralPool finds the Product to be defective in materials or workmanship, AstralPool will, in its sole discretion, either:

- (a) replace or repair the Product or the defective part of the Product free of charge; or
- (b) Cause the Product or the defective part of the Product to be replaced or repaired by an Authorised AstralPool Service Agent free of charge.

AstralPool reserves the right to replace defective parts of the Product with parts and components of similar quality, grade and composition where an identical part or component is not available.

Goods presented for repair may be replaced by refurbished goods of the same type rather than being repaired. Refurbished parts may be used to repair the goods.

WARRANTY CLAIMS

1. If a fault covered by warranty occurs, the customer must first contact AstralPool at the contact address listed below, or an Authorised AstralPool Service Agent.
2. Any warranty claim must be accompanied by:
 - (a) proof of purchase;
 - (b) full details of the alleged defect; and
 - (c) appropriate documentation (such as historical and maintenance records).
3. The customer must make the Product available to AstralPool or its Authorised AstralPool Service Agent for inspection and testing. AstralPool or its Authorised AstralPool Service Agent will attend the premises where the Product is installed for inspection and testing. If the Product is installed:
 - (a) outside a capital city metropolitan area; and
 - (b) is not within a 20 km radius of an Authorised AstralPool Service Agent;then the customer may have to pay a travel fee.
4. If such inspection and testing finds no defect in the Product, the customer must pay AstralPool's usual costs of service work and testing. If such inspection and testing finds a defect that is not covered by this warranty, the customer must pay AstralPool's usual costs of service work plus any parts and labour required to repair the Product, unless recoverable from AstralPool on the failure of any statutory guarantee under the ACL.

Exclusions

The warranty will not apply where:

- (a) the customer is in breach of the Terms and Conditions of Sale;
- (b) the Product was used for a purpose other than one it was intended for;
- (c) the Product was repaired, modified or altered by any person other than AstralPool;
- (d) the Product has not been installed, maintained and/or operated in complete compliance with the installation and operating instructions and any instructions by AstralPool;
- (e) the Product has been subject to accident, negligence, alteration, abuse or misuse.

The warranty does not extend to:

- a) normal wear and tear;
- b) weather and other environmental conditions including but not limited to storm, flood, and/or heat wave damage; or
- c) service and maintenance items.

Examples of exclusions include but are not limited to:

- running pump without sufficient water flow
- addition of chemicals directly to skimmer box

Commercial Installations

On commercial installations, such as health clubs, motels/hotels and hydrotherapy facilities, the warranty is limited to parts and in field labour (within capital city metropolitan areas or 20 km radius of Authorised AstralPool Service Agents) for a period of 12 months from the date of purchase plus 30 days to allow for installation.

LIMITATIONS

AstralPool makes no express warranties or representations other than set out in this warranty.

The repair or replacement of the Product or part of the Product is the absolute limit of AstralPool's liability under this express warranty.

This warranty is subject to the conditions and limitations listed herein. All warranties apply to the original purchaser of the product and are not transferable to new owners. You must notify Astral Pool upon the failure of any component within the warranty period to make a valid claim.

The warranty offered is only valid when the equipment has been used in a normal manner, for the purpose for which it was intended and in accordance with the operating and instruction manual. The replacement of maintenance items used in routine general maintenance are not covered by this warranty. Maintenance items may include (but not limited to);

- Union and lid gaskets / o' rings
- Mechanical seal
- Pre filter basket

This warranty does not cover any equipment that has been improperly installed, misused, neglected, damaged whether intentionally or accidentally, or repaired/replaced without authorization from Astral Pool or altered in any way from its original form. Specific items that will void warranty are (but not limited to);

- Use in non swimming pool applications
- Incorrect power supply and/or connection
- Addition of salt, chlorine and/or other pool chemicals through the skimmer

Extreme operating conditions beyond the control of Astral Pool such as improper power supply, extreme temperatures or other conditions that adversely affect the performance or life of the equipment will void the warranty. Insect infestation or penetration by sand, dust or other foreign bodies will void warranty.

Where in field labor warranty is provided, a 20km radius from an authorized Astral Pool agent is applied. If the location of the equipment is outside this area, travel charges will apply. If your request for a service call is deemed to be non warranty, you will be charged for a diagnostic service call.

Astral Pool reserves the right to repair or replace defective components or products at its sole discretion.

Astral Pool shall have no liability for incidental or consequential damages or delays caused either directly or indirectly by any malfunction of or defect of or failure of the equipment.

Where the equipment is installed in commercial situations including (but not limited to) hotels, motels, caravan parks, health clubs, public pools, body corporate installations, etc the warranty is limited to 12 months.

Proof of Purchase must be retained for all warranty claims. Warranty will not be considered without Proof of Purchase. No person is authorized to make any representation or warranty on behalf of Astral Pool without express written consent from Astral Pool.

Record your Equipment details here for quick reference:	
Model No.:	_____
Serial No.:	_____
Inst date.:	_____
Installer.:	_____

